

VERTICAL BLINDS

VJ092-S



Vertical blind complete system for mounting on the ceiling with mounting clips. Mounting brackets for wall mounting at an additional cost.

- 1 Top rail in matt white, natural anodized, window grey or matt black
- 2 Drawstring and reversible chain in white, grey or black
- 3 lower end with weighting plates

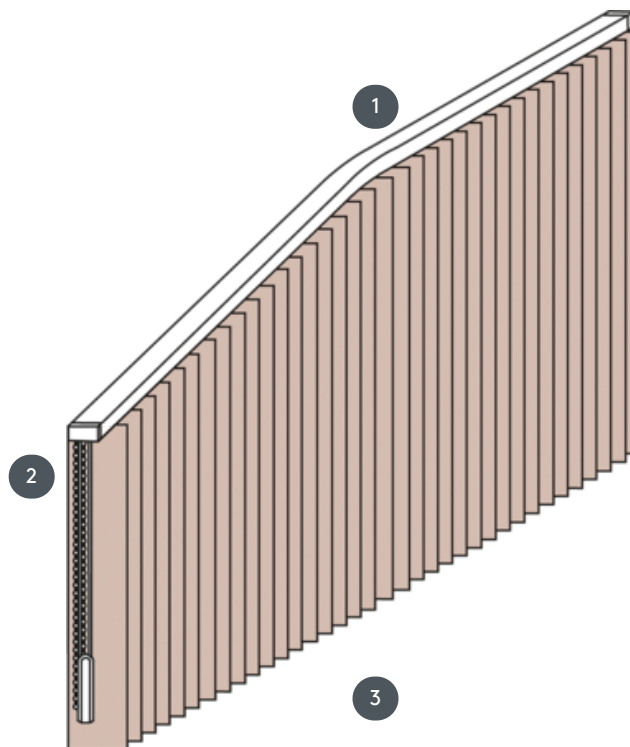

rassemblement

ceiling, wall or built-in profile

min./max. dimensions

max. width: 560 cm, max. height: 400cm
smallest radius for 89 mm blade: 50 cm
smallest radius for 127 mm blade: 50 cm

Mechanical color

matt white (RAL 9016)
natural anodized aluminum (E6-EV1)
Window grey structure (RAL 7040)
matt black structure (RAL 9005)
RAL special painting on request (at an additional charge)

waiter

With a drawstring and reversible chain in white, grey or black
Operation either left or right